



©2017 DESIGNED BY PLAYSTEAM EDUCATION LIMITED, LONDON.  
WEBSITE: WWW.PLAYSTEAM.COM EMAIL: INFO@PLAYSTEAM.COM ADDRESS: SUITE 35 - 36 THE DESIGNWORKS,  
PARK PARADE, LONDON, NW10 4HT. MANUFACTURED BY HANGZHOU ZT MODEL COMPANY LIMITED. ADDRESS: NO 6  
MINGDE RD., PUYAN, BINJIANG, HANGZHOU, CHINA.

PLAY • READ • INSPIRE



# THE LEARNING BOOKLET

— FOR THE PLANT MAZE —  
*Read to be inspired!*

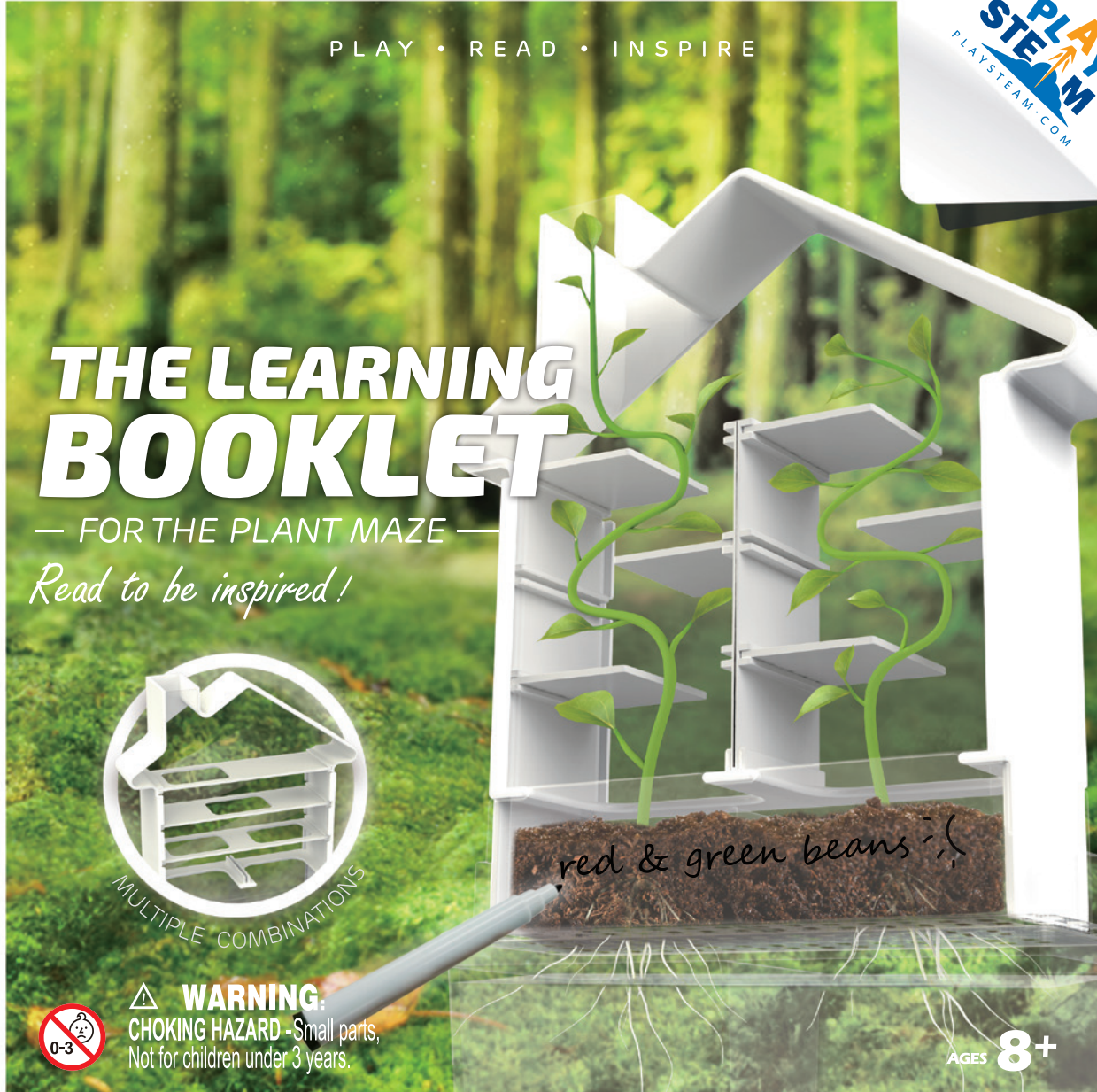

MULTIPLE COMBINATIONS

red & green beans

**WARNING:**  
CHOKING HAZARD - Small parts,  
Not for children under 3 years.

AGES 8+



## TABLE OF CONTENTS

Warning Message	01
Package Contents	04
Installation Instructions	07
Activities 1	13
Activities 2	15
Activities 3	21
Activities 4	25
Activities 5	29
Activities 6	35

## **WARNING MESSAGE**

### **GENERAL WARNING**

*Before you begin, please read through the instructions together with your children. Make sure you understand the safety messages. Please keep the packaging and instructions, as they contain important information.*

*This kit is designed for children over 8 years of age.*

*CHOKING HAZARD - Small parts, not for children under 3 years.*

*Children should have parental supervision when assembling the product.*

*Please clean the product with a clean cloth when necessary.*

# **1 | WARNING MESSAGE**





**2** | **PACKAGE**  
**CONTENTS**



## Package Contents

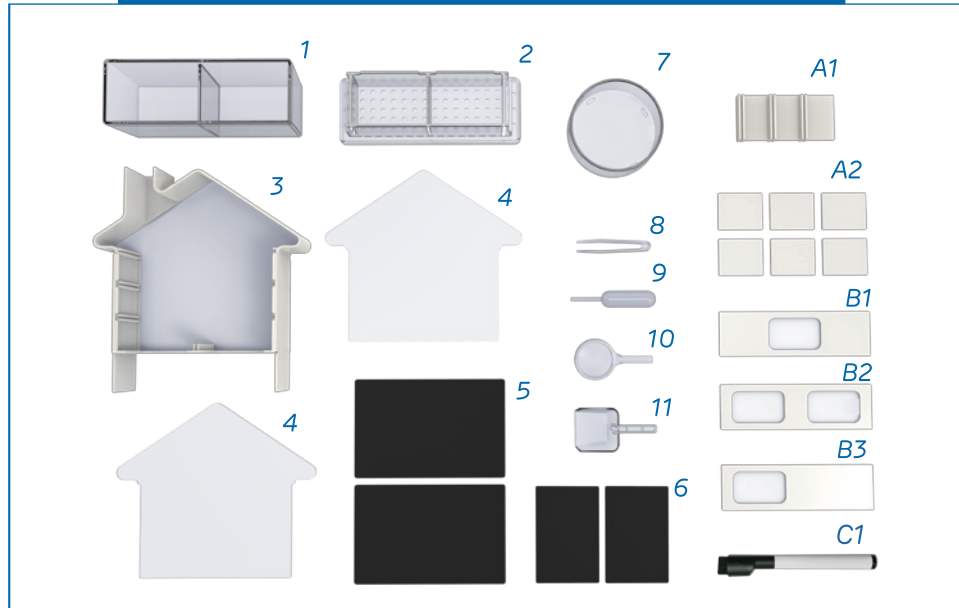

Conforms to ASTM D-4236

Serial	Name	Quantity	Serial	Name	Quantity
1	Water Tank	1	10	Magnifying Glass	1
2	Soil Tank	1	11	Shovel	1
3	House Frame	1	A1	Vertical Panel	1
4	House Transparency Cover	2	A2	Small Dividing Panel	6
5	Shading Card (full size)	2	B1	Long Dividing Panel A	1
6	Shading Card (half size)	2	B2	Long Dividing Panel B	1
7	Cultivation dish	1	B3	Long Dividing Panel C	1
8	Tweezers	1	C1	Doodling pen	1
9	Dropper	1			

## Necessary but not included



Cotton

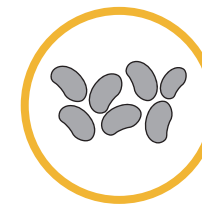

Beans or Seeds



Soil



Vinegar

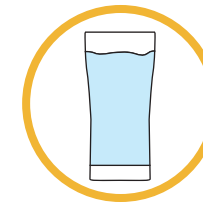

Water

# 3 | INSTALLATION



## Installation

1 Lock the Soil Tank on top of the Water Tank.

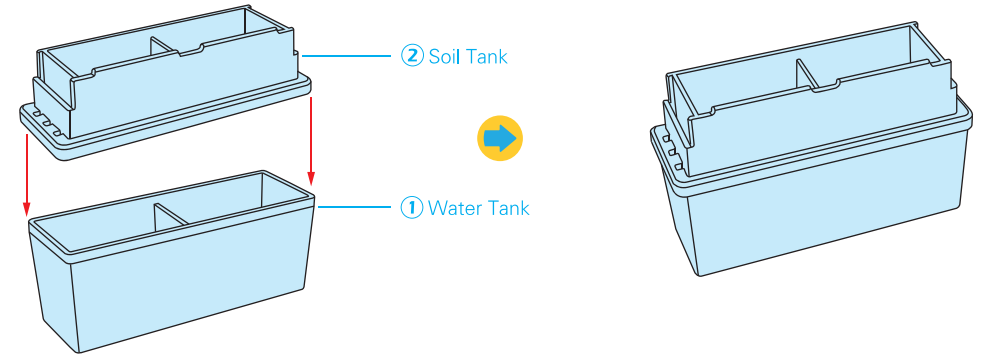

2 Slide the House Frame into the Soil Tank as illustrated.

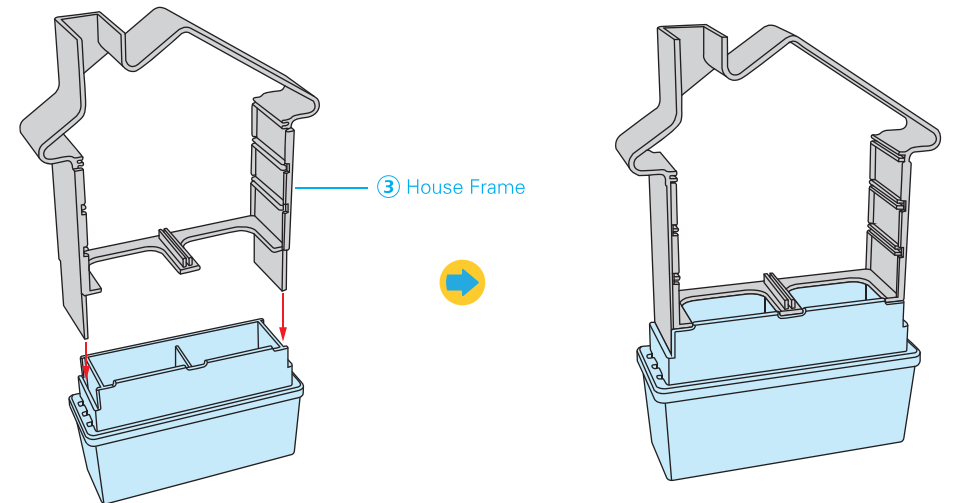

3 Insert the House Transparency Cover from top to bottom .

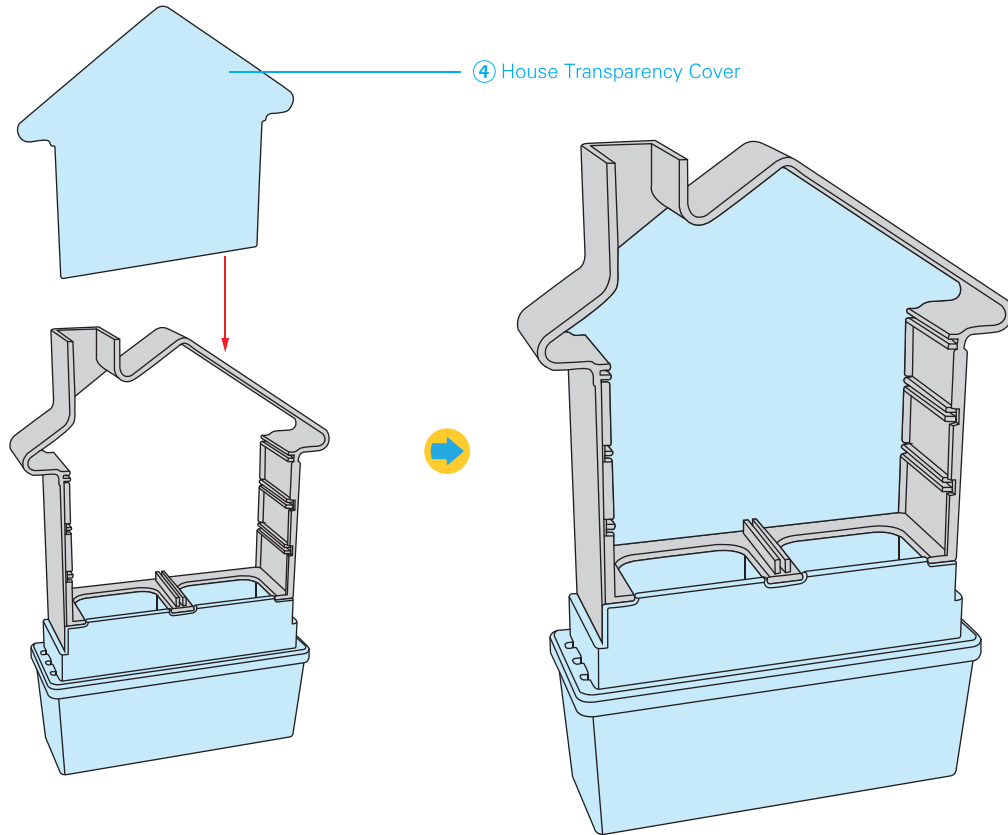

## Maze Type A

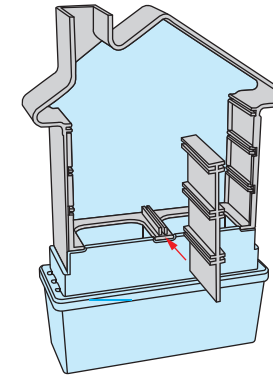
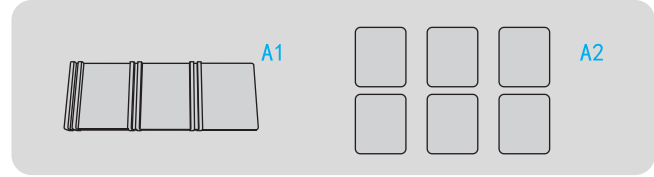

A1 Vertical Panel

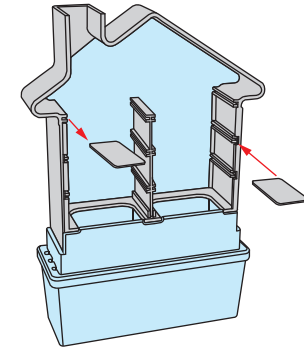

A1 Small Dividing Panel

Insert the Vertical Partition first and feel free to design the escape path as illustrated with the Cell Partitions.

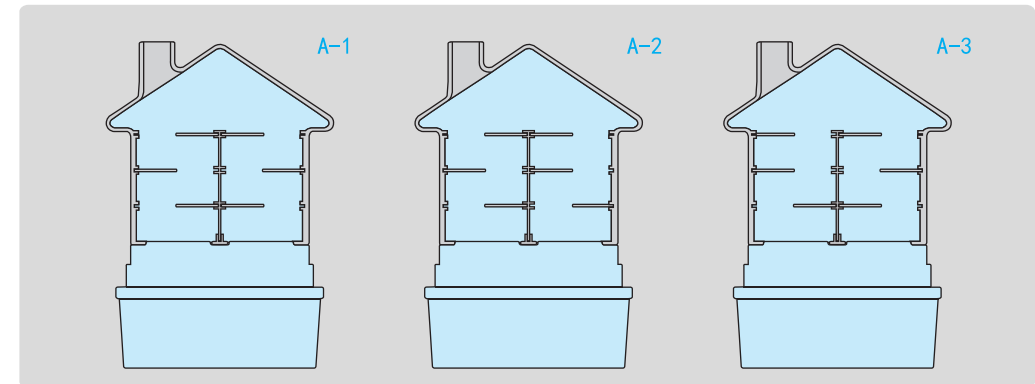

## Maze Type B

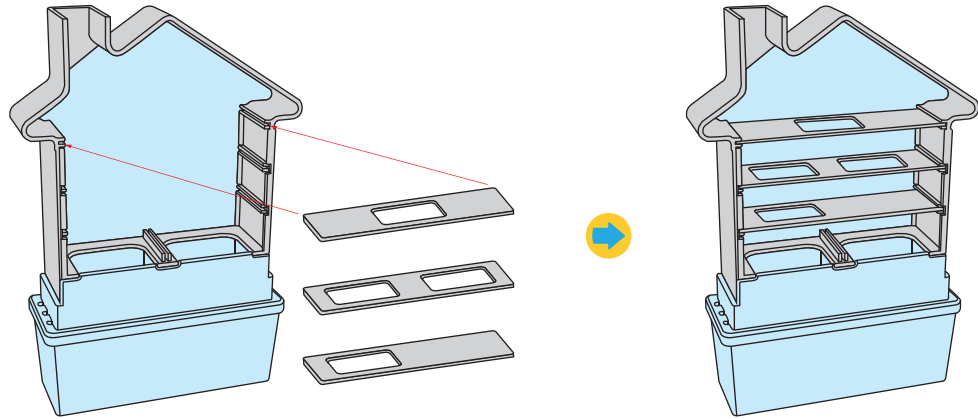
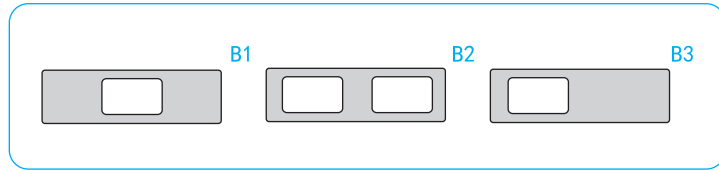

Design the escape path as illustrated with the Storey Partitions.

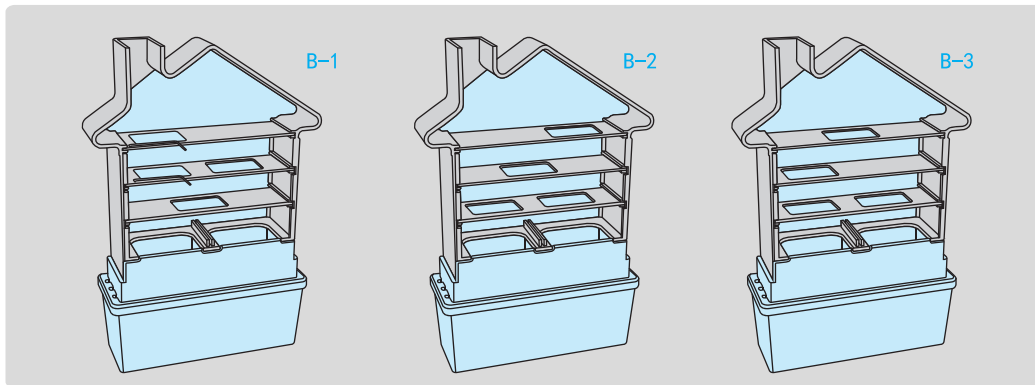

# 4 | ACTIVITIES





## ACTIVITY 1 – GEOTROPISM

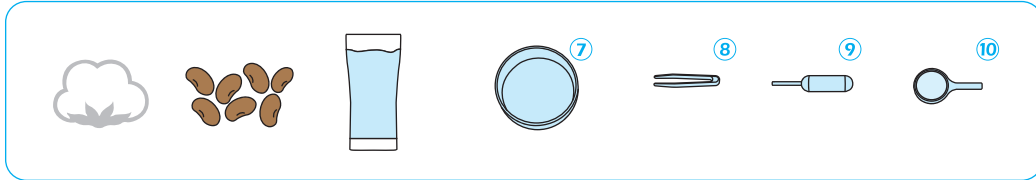

1 Before you begin, prepare all the required tools and materials.

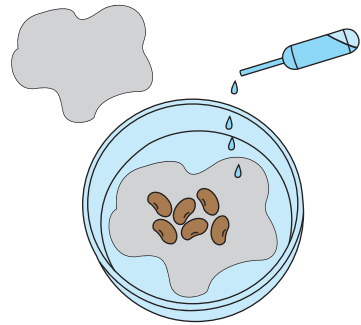

2 First, spread a layer of cotton over the bottom of the cultivation dish. Use the dropper to add a suitable amount of water. Add enough water to thoroughly moisten the cotton, but don't flood it with too much water.

3 Place the seeds or beans onto the cotton (4 to 6 pieces).

4 Then, spread another layer of cotton over the seeds/beans, and moisten the top layer with the dropper.

5 In warm weather, the seeds/beans will begin to sprout within 1 to 2 days.

6 Children can check the sprouts' growth daily with the magnifying glass.

7 When the roots and stems are still less than 1cm in length, we can easily see a natural phenomenon: the roots are growing downward, while the stems are growing upward.

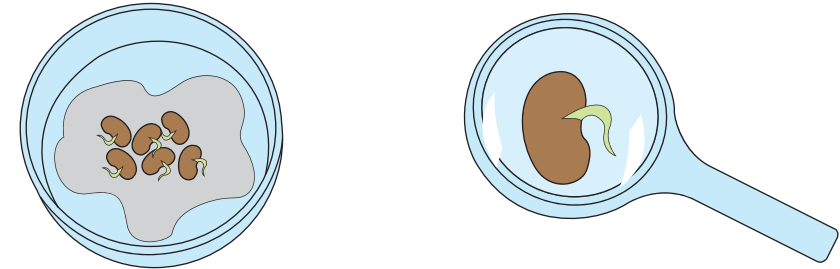

8 In botany, this phenomenon is called “geotropism”. When the roots naturally grow downward, this is called “positive geotropism”. When the stems naturally grow upward, it is called “negative geotropism”.

9 Using the tweezers, we can carefully and gently turn over the sprouted bean/seed so that the roots point upward and the stem points downward, then cover it again with the moist cotton.

10 In only 1 or 2 days, the roots have mysteriously changed direction again, twisting back downward toward the ground, while the stem has twisted upward to continue growing toward the sky!

11 Plants are smart - they know what direction they need to grow in.

## ACTIVITY 2 — PLANT ESCAPE

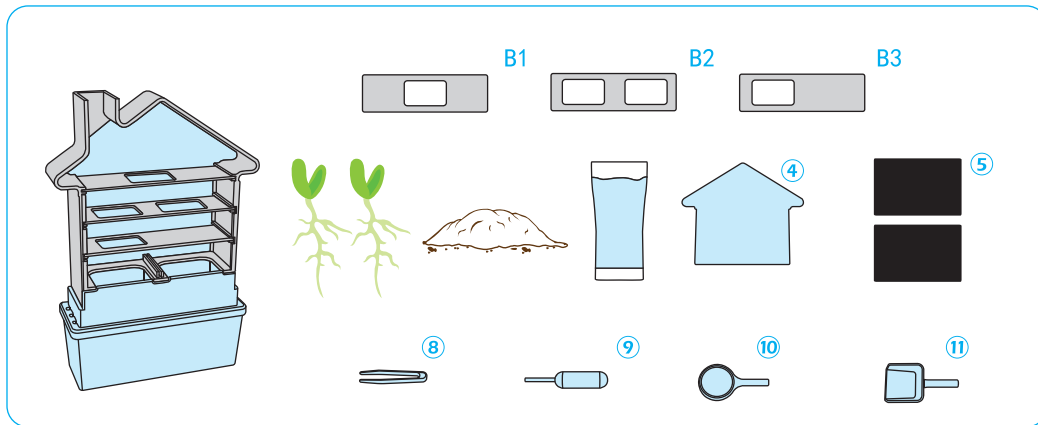

- 1 Before you begin, prepare all the required tools and materials.
- 2 First, prepare the water tank and fill it up to 3/4 with water.
- 3 Next, place the soil tank on top and use the shovel to fill it with an even layer of soil.
- 4 Use the tweezers to gently pluck the sprouted seeds/beans out of the cultivation dish and transfer them to the soil tank.
- 5 Plant the sprouts so they are buried up to the middle in the soil.
- 6 Then install the roof of the house.

- 7 In the center of the house, we use the long dividing panel to create an "escape route" for the plants. We recommend keeping the holes staggered (zig-zagging left and right).
- 8 Before installing the two transparent panels at the front and back of the cover, first use the dropper to add 4-5 squirts of water to help the plants grow.
- 9 Install the transparent front and back panels.
- 10 Install the two shade panels ( full size) included in the kit. Make sure the black side faces inward.
- 11 From time to time, we can move the shade panels aside to check on the sprouts' progress. See how the plants gradually grow from the soil through the escape holes we set for them all the way to the ceiling!
- 12 Plants will grow in the direction of the light, following the light through the holes. Everything plants do is because of light. In botany, this phenomenon of plants following light is called "phototropism".

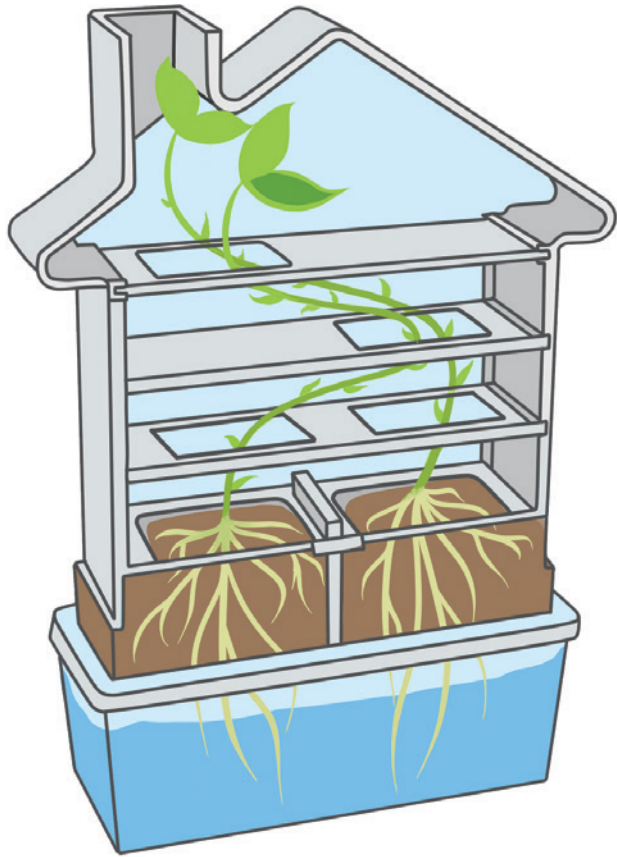

## How does it work?

- 13 Actually, it all happens because of the photophobic (light-fearing) plant growth hormone, known as auxin.
- 14 Auxin regulates plant growth, especially the growth of cells in the stem and the lateral growth of cells within the root.

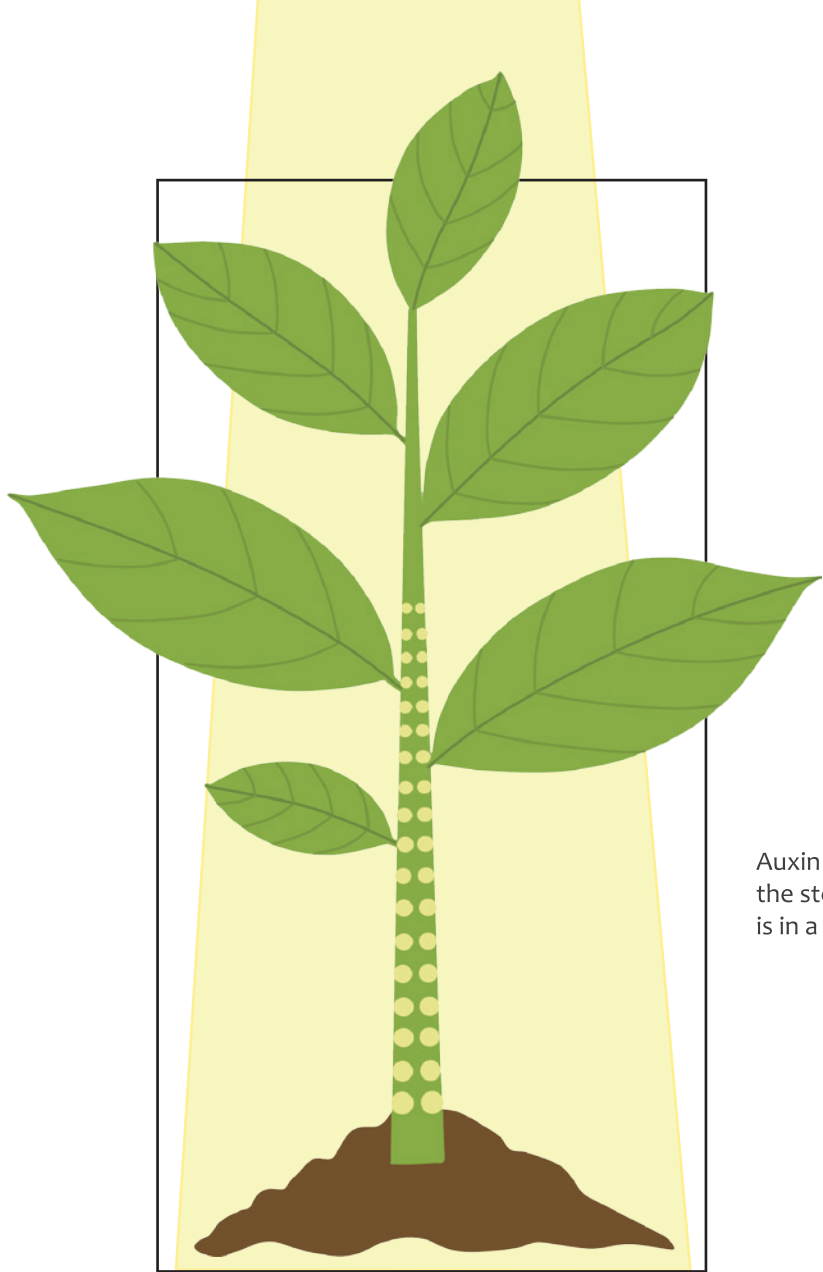

Auxin is evenly-distributed among the stem when the light source is in a top and central position.

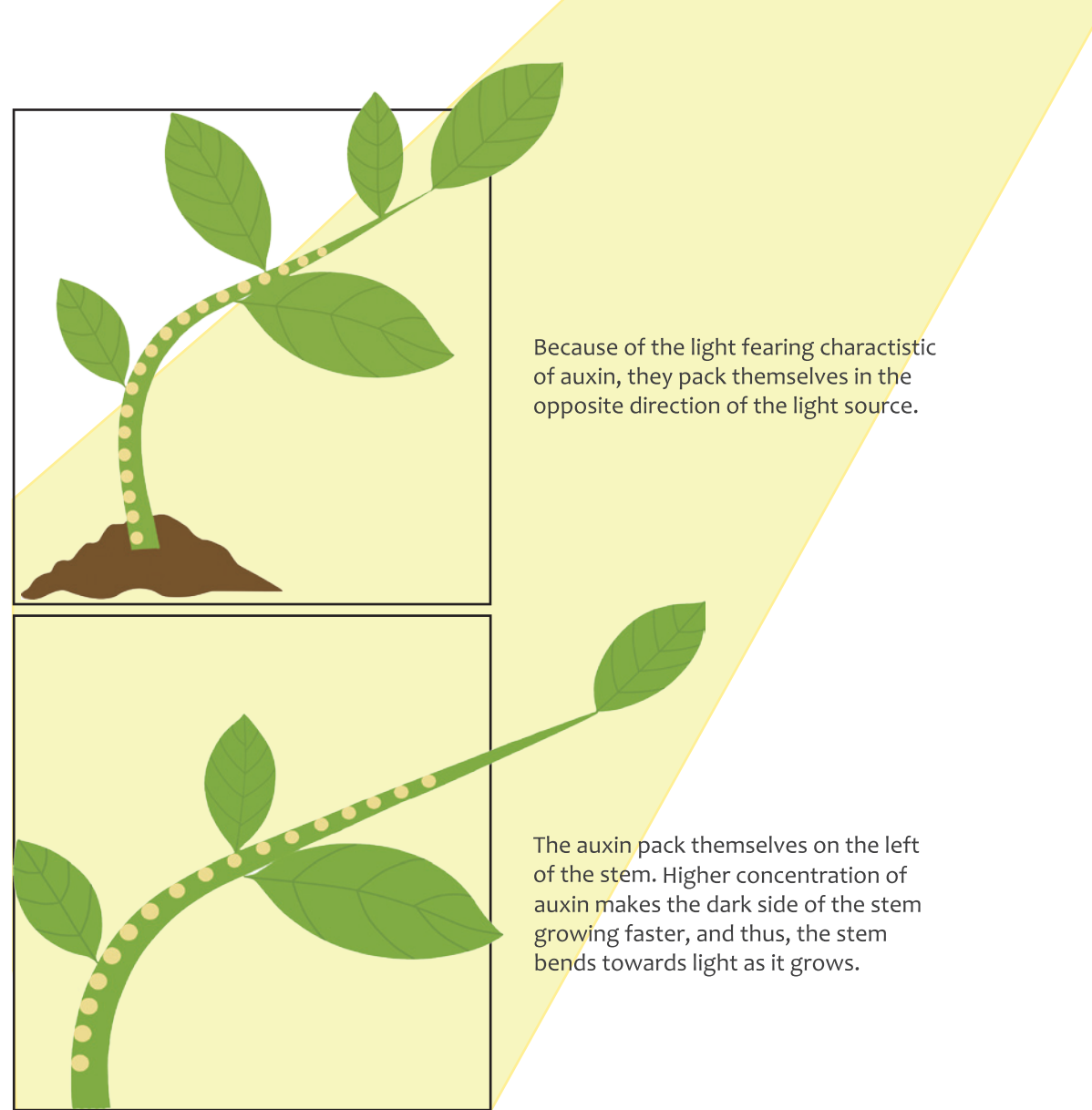

Because of the light fearing characteristic of auxin, they pack themselves in the opposite direction of the light source.

The auxin pack themselves on the left of the stem. Higher concentration of auxin makes the dark side of the stem growing faster, and thus, the stem bends towards light as it grows.

### ACTIVITY 3 — PLANT RACE

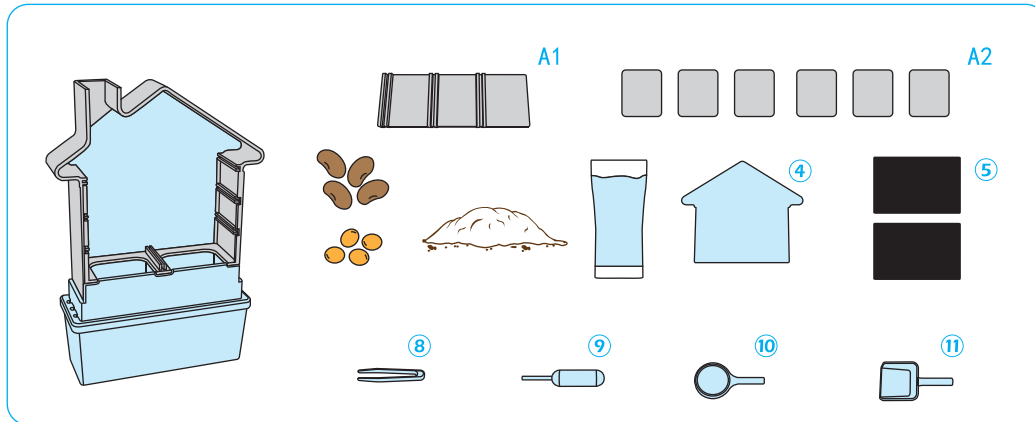

- 1 Before you begin, prepare all the required tools and materials.
- 2 Using the method from activity one, separately germinate the two different types of beans or seeds and let them grow until they are 1-2 cm tall.
- 3 Plant the sprouts in the soil tank, with one type at one end and the other at the opposite end.

- 4 Assemble the outer wall of the house.
- 5 Install the vertical panel in the center position and create a corresponding dividing panel. Children can install the panel as shown in the diagram, or can use their imagination to create special racetracks for the plants.
- 6 Install the black shade panels (full size) inside the front and back walls of the unit.
- 7 As the plants grow, children can remove the shade panels to check the plants' development and see which one reaches the ceiling first.

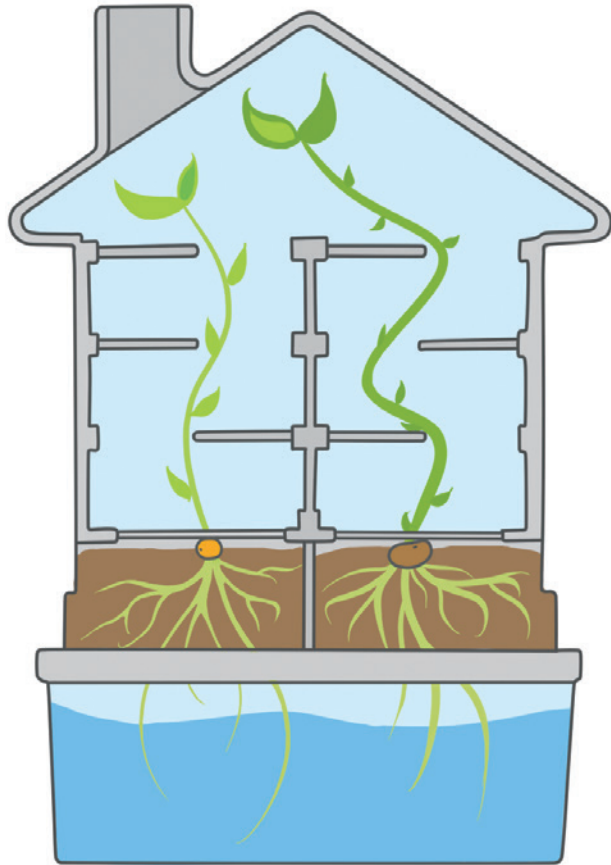

### How does it work?

- 8 Different plants have different ways and speeds of growth. Some types of plants will naturally grow faster, and others grow slower. Besides their growth speed, there are other differences we can observe in their roots and stems.

Why don't we try to let more types of plant take part in the race?

## ACTIVITY 4 – STRAIGHT PLANT

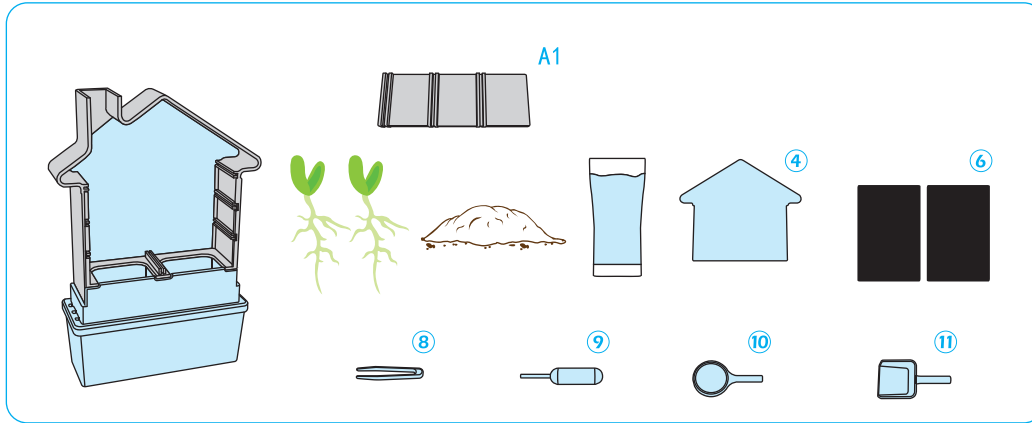

- 1 Before you begin, prepare all the required tools and materials.
- 2 Using the method from activity one, separately germinate the two different types of beans or seeds and let them grow until they are 1-2 cm tall.
- 3 Select the biggest and strongest sprouts and plant them in the soil trough, with one type at either end.
- 4 Assemble the outer walls of the house.
- 5 Install the vertical panel in the center position.
- 6 Use the black shade panels (half size) to shade the sprouts on the side of the house with the chimney. The other side doesn't need a shade panel.
- 7 As the plants grow, children can remove the shade panels to check their progress and see which side reaches the ceiling first.
- 8 Children will discover that the sprouts in the side of the house covered with shade panels grow faster and straighter, while the sprouts without a shade panel grow in all directions, neither as tall nor as straight as the shaded ones.

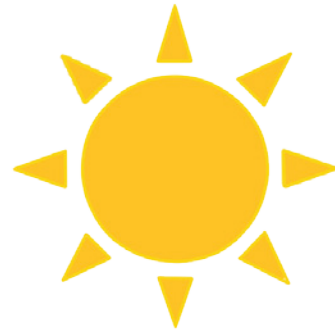
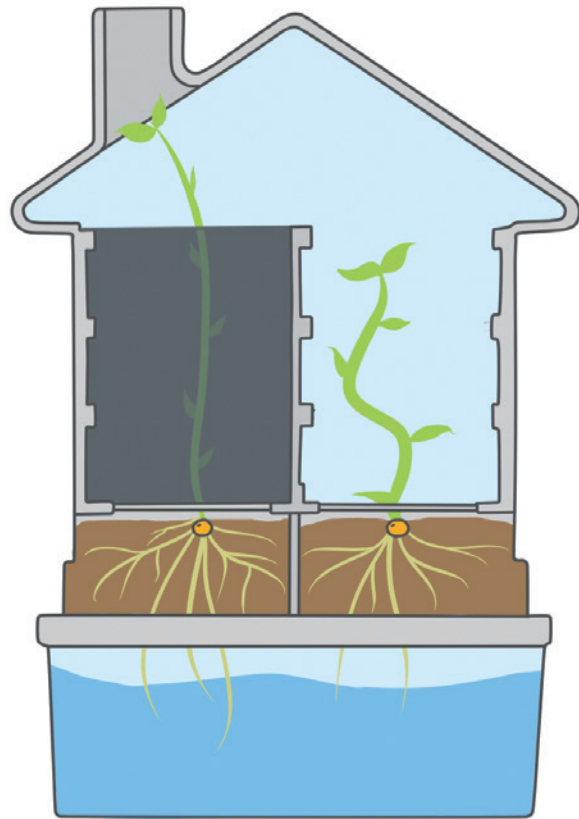

### How does it work?

- 9 Because the sprouts in the shaded side of the house must rely on the light from the chimney for the energy to grow, they will put all of their energy into growing in that direction. On the other hand, the sprouts on the un-shaded side of the house get light from all directions, so they can grow whichever way they like.

This is the reason why, in dense tropical rainforests, plants all grow very tall and very straight - because they can only get the light they need by being taller than the plants around them.



## ACTIVITY 5 – ACID RAIN

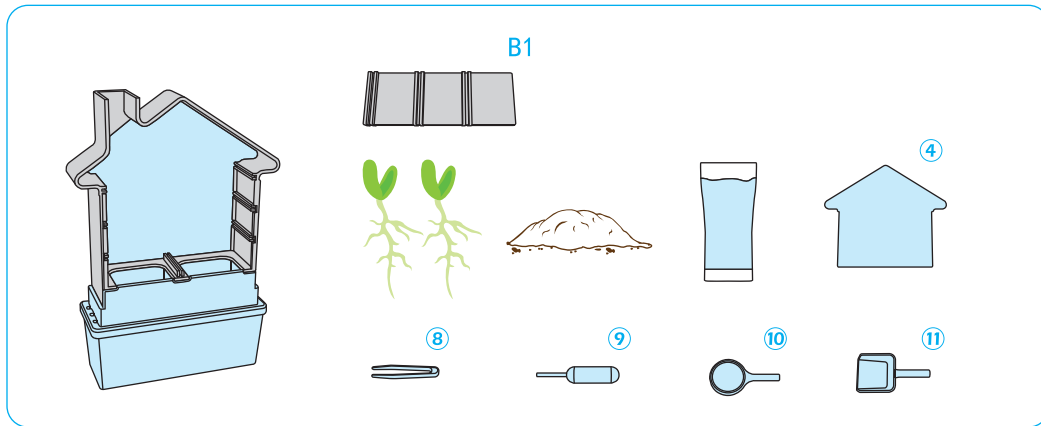

- 1 Before you begin, prepare all the required tools and materials.
- 2 Using the method from activity one, separately germinate the two different types of beans or seeds and let them grow until they are 1-2 cm tall.

- 3 Select the biggest and strongest sprouts and plant them in the soil tank, with one type at either end.
- 4 Assemble the outer walls of the house.
- 5 Install the vertical panel in the center position.
- 6 Squeeze three droppers of vinegar into the soil near one of the seeds.
- 7 We will discover that the plant growing in the vinegar-treated soil grows much slower than the others -it may even wither up and die.

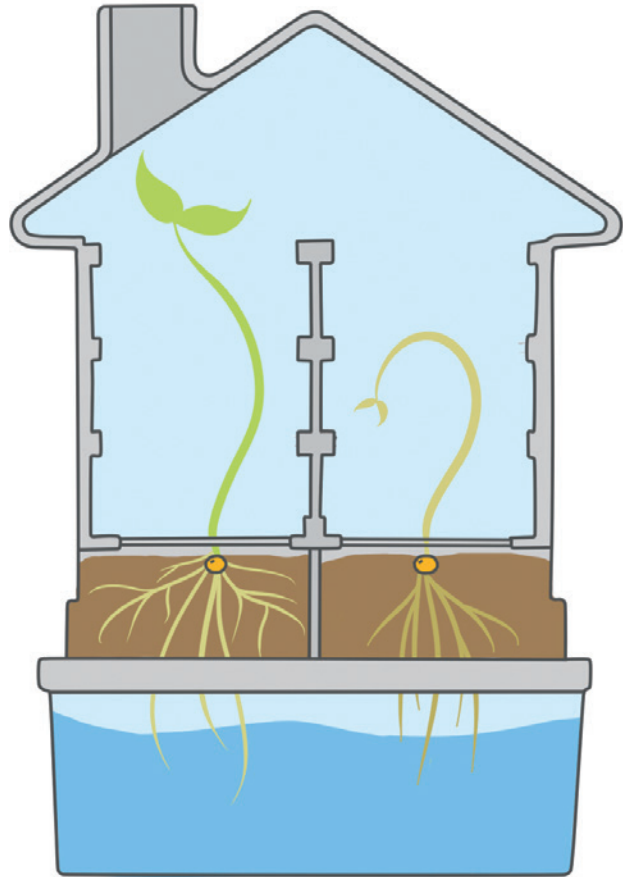

### How does it work?

- 8 This experiment demonstrates the negative effect that acid rain has on plants in real life.

Acidic soil and water will influence the plants' growth - it will even threaten their health.

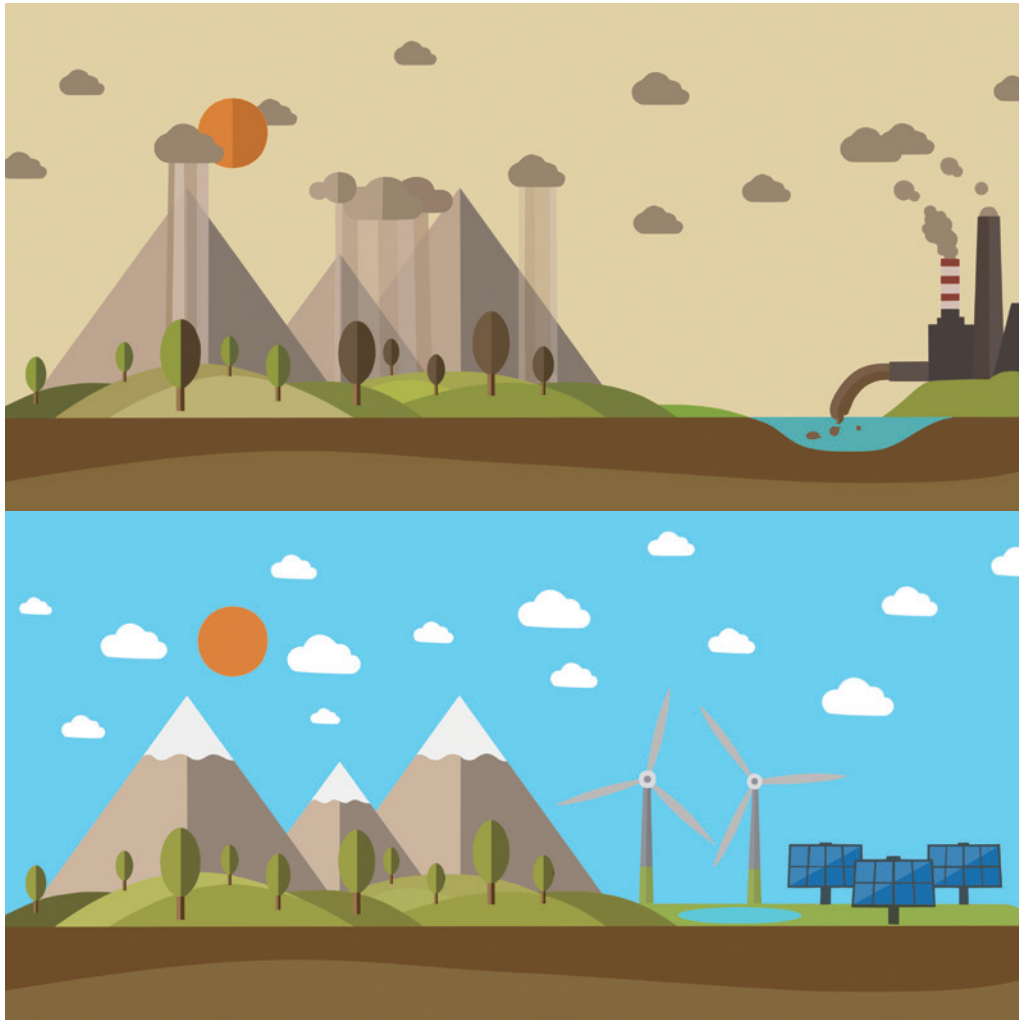

### So, where does acid rain come from?

- 9 Acid rain is mainly caused by burning fossil fuel. Apart from this, it threatens the growth of plants, and it pollutes the air. As a result it affects our health.

It is the reason why solar energy, wind turbines, and other types of green energy are getting more popular. So, let's be green by saving energy and reduce the usage of fossil fuels.

Ride a bicycle instead of driving a vehicle for short distances.

Switch off the light when it is not being used.



## ACTIVITY 6 — EXTENSION

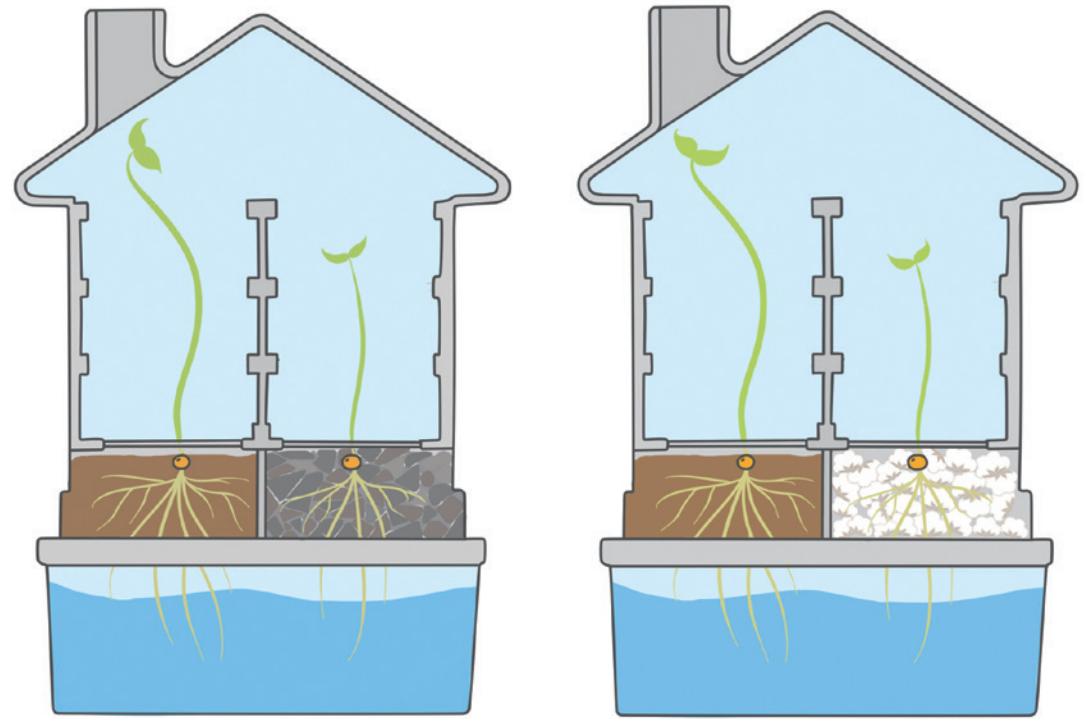
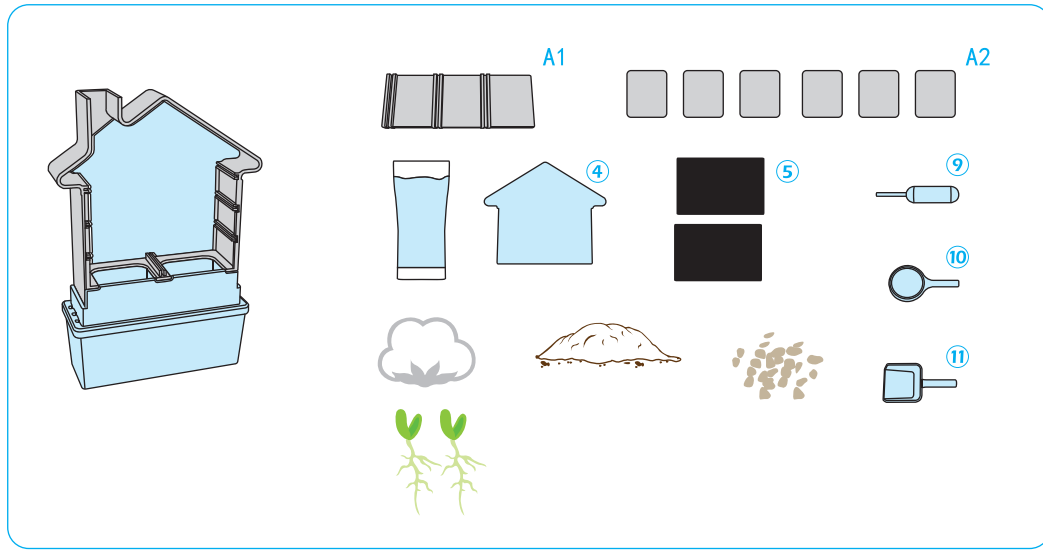

- 1 Prepare the materials and tools as listed above.
- 2 You can use different bedding to grow the beans and test how it affects the growing conditions, for example, soil, cotton, rocks, etc.
- 3 Tons of possibilities await your exploration!