

FALCON 800

2.4GHz RC RTF Plane
Instruction Manual

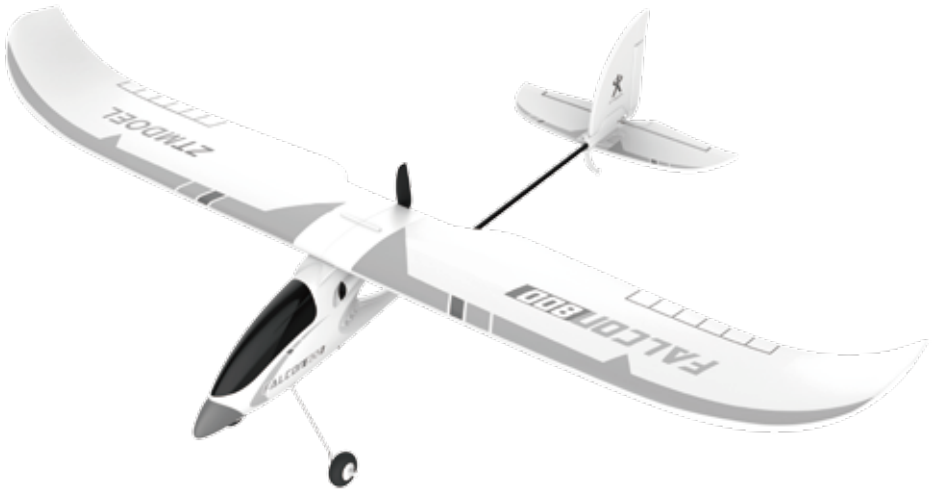

Reliable & Durable



Aerobatic flight



Easy-Assembly



Glue free

Durable Foam construction

Reliable 2.4G Control system

Efficient and Powerful 180 size Motor with 10A ESC

Wingspan: 890mm Length: 670mm, 233g flying weight

Battery: 7.4v 2S 420mAh 20C Lithium Polymer (included)

USB Battery Charger (included)



ages: 14+

The packing has important information.
Please keep it.

IMPORTANT! Read the ENTIRE instruction guide to become familiar with the model before operating. This guide contains instructions for safety, operation, and maintenance. It is essential to read and follow all the instructions and warnings, prior to assembly or use in order to operate correctly and avoid damage or injury.

NOTICE: All instructions, warranties and other collateral documents are subject to change at the sole discretion of ZT Model.

LITHIUM BATTERY WARNING



This model airplane includes a lithium polymer (LiPo) battery. Improper handling may result in damage or injury. You are responsible for following all safety precautions as outlined in this instruction manual:

- Very important! Never leave the charger and LiPo battery unattended while charging!
- Do not charge a LiPo battery on a flammable surface or near combustible materials.
- Never charge inside a vehicle or at a location that could be damaged in the event of a LiPo fire.
- Keep out of reach of children!
- Do not charge or use a battery that is deformed, bent, or has any type of visible damage.
- You must only use the included, factory-approved charger with this LiPo battery.
- Disconnect the battery and unplug the charger if the charge time exceeds 3 hours.
- Disconnect the battery and unplug the charger after the charge is complete.
- Keep LiPo batteries out of reach of animals. A punctured battery may cause a harm.
- Never disassemble or modify a battery, its wiring, or puncture cells, as this may result in fire.
- Do not allow the battery to short circuit by touching exposed wires together.
- LiPo batteries must always be recycled or disposed of properly.

Charger used with the toy are to be regularly examined for damage to the cord, plug, enclosure and other parts, and that, in the event of such damage, the toy must not be used with this charger until the damage has been repaired.

WARNINGS :

Please keep a safe distance from the high-speed rotating propeller to avoid the risk of wound and cut.

WARRANTY

Do not return your model to the Store. ZT Model will repair or replace factory defects for 90 days from the date of purchase. This warranty specifically does not cover crash damage, misuse, or abuse. To make a warranty claim, please contact our product support team. This warranty applies only if the product is operated in compliance with the instructions and warnings provided.

Flite Test assumes no liability except for the exclusive remedy or repair of parts as specified above. ZT Model shall not be liable for consequential, crash or incidental damages.

SAFETY PRECAUTIONS

- Warning: Do not modify or alter this model.
- This model is suitable for ages 14 and above.
- You must always disconnect and remove the battery from the airplane when not in use.
- Do not operate near people or animals.
- Always remove the propellers when working on the airplane.
- Important! Always unplug the battery from the charger after charging is complete.
- Before each flight, examine all parts for damage. If any is found, do not operate until the damage has been repaired.
- Keep the airplane and battery away from direct sunlight and/or heat sources.

Electrical and electronic equipment that are supplied with batteries

(including internal batteries)

WEEE Directive & Product Disposal

At the end of its serviceable life, this product should not be treated as household or general waste. It should be handed over to the applicable collection point for the recycling of electrical and electronic equipment, or returned to the supplier for disposal.

Internal / Supplied Batteries.

This symbol on the battery indicates that the battery is to be collected separately. This battery is designed for separate collection at an appropriate collection point.



PARTS LAYOUT

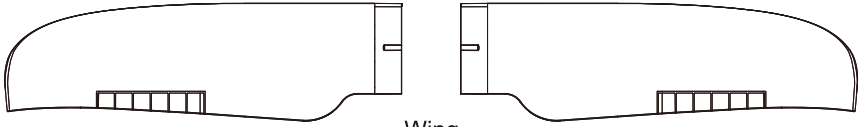

Wing

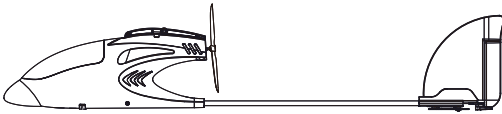

Fuselage



Propeller

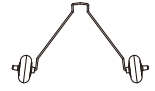

Landing Gear



Tail Skid

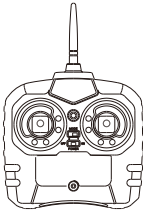

Transmitter



Control Sticks

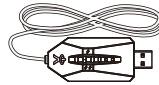

Charger



Lithium battery
7.4V 420mAh

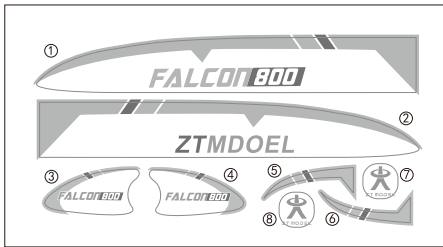

Stickers

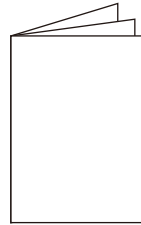

Instruction Manual

Required

4*1.5V AA size batteries for the transmitter.

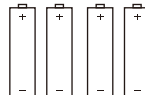

CHARGING THE BATTERY

Fully charge the Lithium polymer (Lipo) Battery before use.

- 1.The charger features two charging rates for various applications. For this battery use the 0.6A rate (single lightning bolt).
- 2.Plug the charger into a 5v power adaptor. The LED's will flash indicating that no battery is connected.
- 3.Plug the battery into the charger.
- 4.The LED will glow solid RED when charging.
- 5.When the LED turn GREEN, charging is complete.
- 6.Unplug the battery from the charger.
- 7.Unplug the charger from the power adaptor.

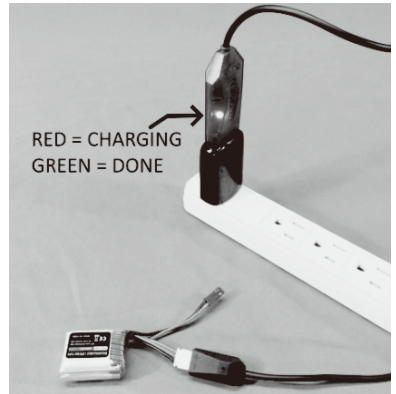
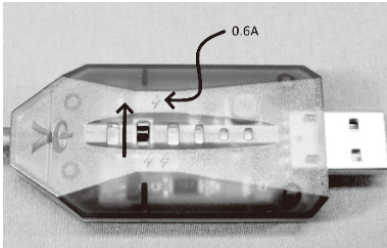

NEVER leave the battery unattended when charging.

ALWAYS disconnect the charger and battery when charging is complete.

TRANSMITTER SETUP

- 1.Attach the gimble sticks to the transmitter. They will simply push into place.



2. Install (4) 1.5v AA batteries into the back of the transmitter. Make sure the polarity matches the (+/-) indicators.
3. Familiarize yourself with the transmitter controls.

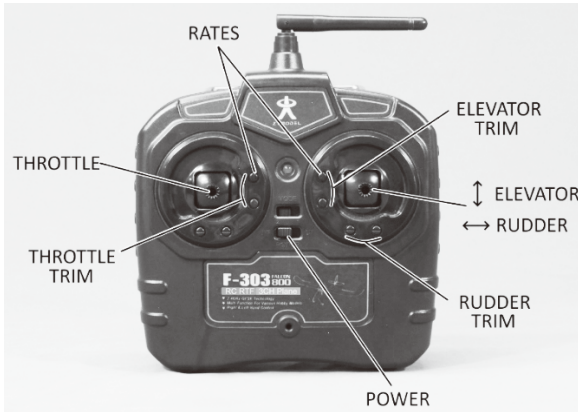

4. When ready to fly:

- a. To arm the motor, after turning on the transmitter, move the throttle stick full up and then full down. The LED will be flashing at first and then glow steady. You will also hear a beep. The airplane motor is now armed and ready for flight.
- b. Low/High rates. To toggle the control rates from low to high (and back). Push and release the two upper trim buttons at the same time. The LED will be steady on for low rate and slow flash for high rate.
- c. Use the trim buttons to adjust to fine tune the airplane so it flies straight and level.

FCC Information

This device complies with Part 15 of the FCC Rules. Operation is subject to the following two conditions: (1) this device may not cause harmful interference, and (2) this device must accept any interference received, including interference that may cause undesired operation.

Warning: Changes or modifications to this unit not expressly approved by the party responsible for compliance could void the user's authority to operate the equipment.

This equipment has been tested and found to comply with the limits for a Class B digital device, pursuant to part 15 of the FCC Rules. These limits are designed to provide reasonable protection against harmful interference in a residential installation.

This equipment generates, uses and can radiate radio frequency energy and, if not installed and used in accordance with the instructions, may cause harmful interference to radio communications. However, there is no guarantee that interference will not occur in a particular installation. If this equipment does cause harmful interference to radio or television reception, which can be determined by turning the equipment off and on, the user is encouraged to try to correct the interference by one or more of the following measures:

- Reorient or relocate the receiving antenna.
- Increase the separation between the equipment and receiver.
- Connect the equipment into an outlet on a circuit different from that to which the receiver is connected.
- Consult the dealer or an experienced radio/ TV technician for help.

ASSEMBLY

1. Attach the tail skid. Press firmly in place.
2. Attach the main gear to the fuselage. If loose, bend the gear outward slightly.

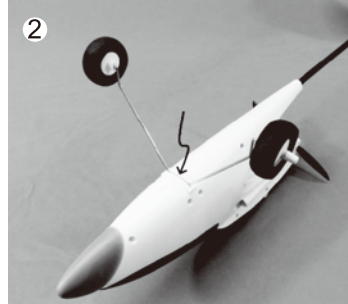
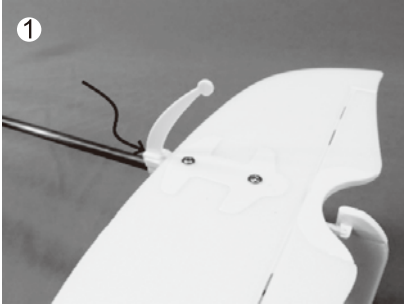

3. Attach the wings to the fuselage. Push them on until they snap. To remove, push the small button release on the bottom of the wing while pulling outwards.

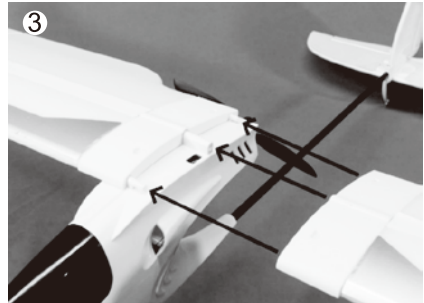

STICKERS

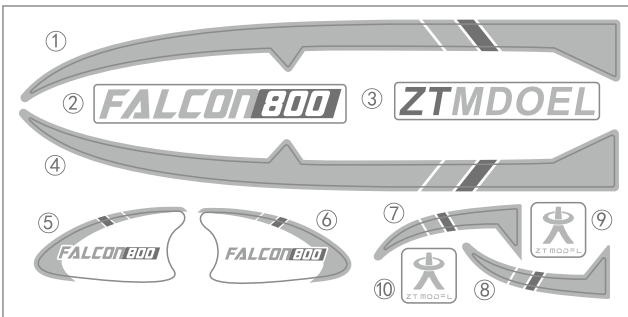

Stickers

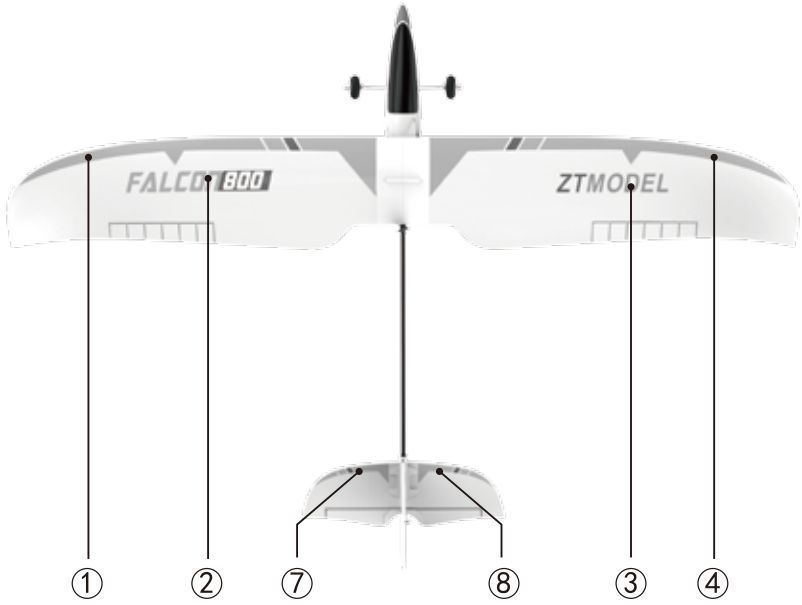

CENTER OF GRAVITY (CG)

IMPORTANT! DO NOT SKIP THIS STEP.

1. Locate the center of gravity as shown on the bottom of the wing.

With the aircraft upright, use our finger tips and lift at the CG.

a. If the nose drops, move the battery backwards.

b. If the tail drops, move the battery forward.

c. If needed, add additional weight to the nose or tail (as far out as you can) to achieve balance. Stick on weights work great for this.

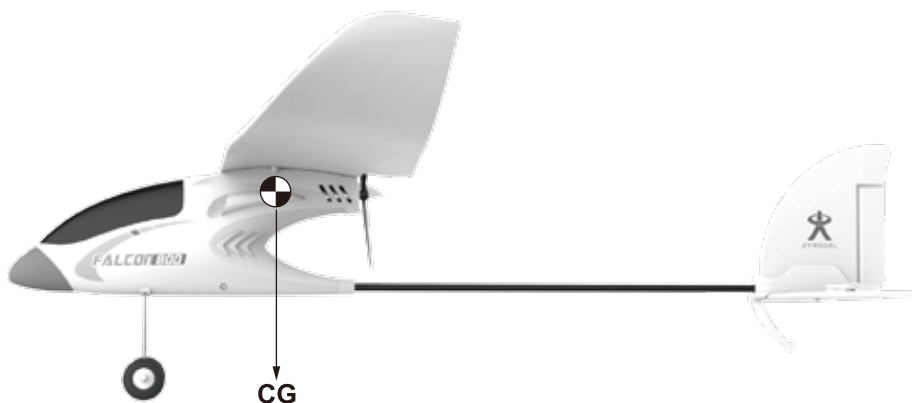

LINKING THE TRANSMITTER

1. In the rare instance the airplane does not respond to the transmitter, you may need to relink.

a. With the transmitter off, lower the throttle stick.

b. Push and hold any one of the trim buttons on the transmitter while simultaneously turning on the power. The LED's on the transmitter will flash and the transmitter will briefly beep.

c. Within 5 seconds, plug a charged battery into the airplane. The airplane will then connect to the transmitter and you will have control.

d. Move the throttle from low to high and back to low. The flashing will stop and you are ready to go.

e. The transmitter will remember this link for future operation.

FLYING

Caution: As a rule of thumb “always” assume the propeller could spin at any time. Whenever a battery is installed, stay clear of the propeller!

Understanding the controls:

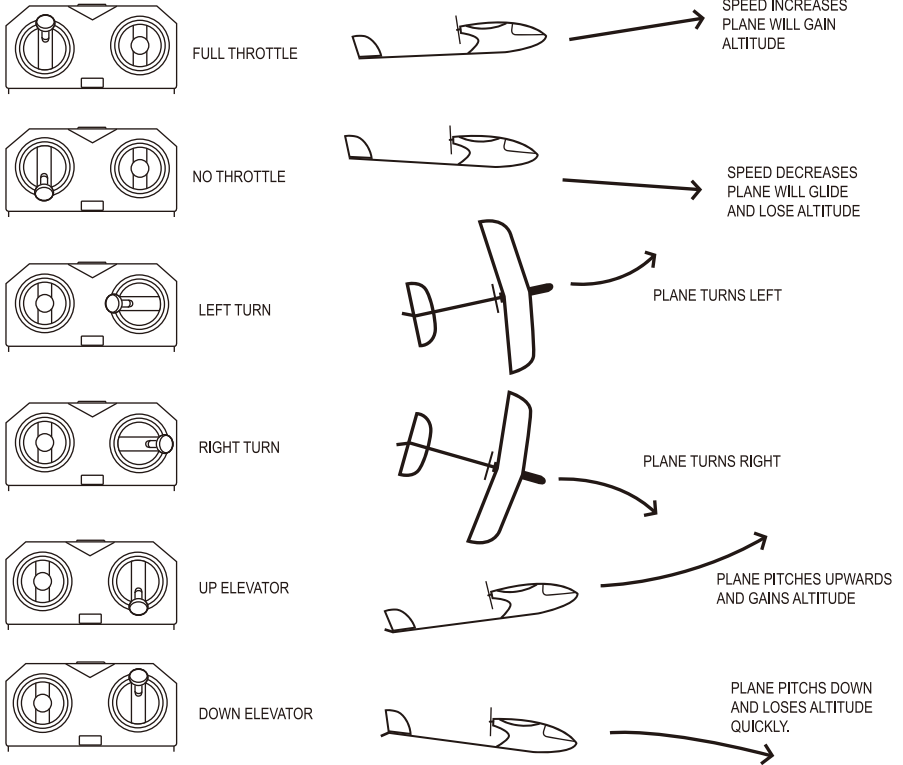

1. Choose a wide-open area away from people, buildings, and power lines.
2. This is a lightweight airplane that gets blown around easily. Only fly in calm wind conditions.
3. Make sure the throttle stick is down and turn on the transmitter.
4. Plug in and install a charged battery. Close the battery door.
5. Move the control sticks to confirm that airplane is responding.
6. Taking off from a runway.
 - a. Place the aircraft on a smooth surface facing into the wind. Gently advance the throttle and the airplane will slowly take off and gently climb. Do not force the airplane in the air using the elevator.

7. Hand launching.

a. Grasp the plane gently from underneath.

b. Face into the wind and point the airplane straight and level (NOT up or down).

c. Advance the throttle to half and gently push the airplane straight forward.

i. DO NOT throw it upwards or downwards, both could result in a crash.

d. Once released, add in more throttle and gently climb out using small control inputs.

8. Flying tips:

a. The plane flies itself. Your job is to control it. When it is pointing where you want it to go. Let go of the sticks and let it fly.

b. A common mistake is to over control the airplane. Gentle movements are best.

c. When learning, make small inputs and then let the stick go back to center.

d. When ready to land, point the plane into the wind and keep the wings as level as possible. Lower the throttle so the plane will descend. When the plane is ready to touch down, reduce the throttle to zero.

e. The stability will hold the hold the plane level however, if you see the plane climb or dive too much use the trim button to trim it level.

9. When the battery drains below a certain point, the motor will automatically shut off. When you notice the power starting to drop, land immediately.

10. IMPORTANT! Always remove and unplug the battery after every flight. If not, the battery may slowly discharge and be permanently damaged.

11. Let the battery cool before recharging.

CARE AND MAINTENANCE







Caution! When working on your plane with the battery installed, always remove the propeller in order to avoid the chance of injury if the motor turns on.

Parts damaged beyond repair can be purchased separately. Often though, parts can be repaired easily, and you can get your airplane back into the air with a little foam safe glue and clear packing tape.

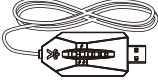
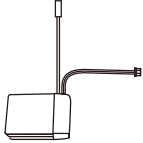
When storing for extended periods, remove the batteries from the transmitter. Store the flight battery at a partial charge state.

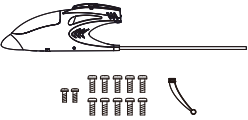
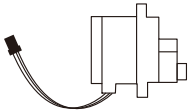
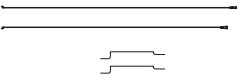
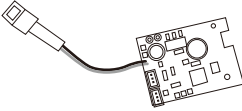
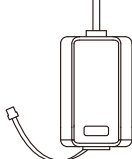
If you feel excessive vibration when the motors turn, check the propellers and motor shafts for damage.

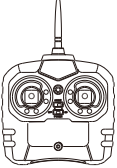
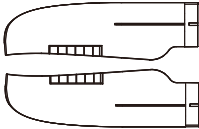
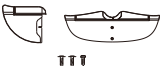
REPLACEMENT PARTS

<p>TC018-01 USB Charger</p> 	<p>TA026-05 7.4v 2S 420mAh 20C LiPo battery</p> 	<p>TA026-09 Propeller Assembly</p> 	
<p>TA026-11 Fuselage Set</p> 	<p>TA026-12 Servo</p> 	<p>TA026-13 Steel wire assembly</p> 	
<p>TA026-14 Receiver</p> 	<p>TA026-15 Motor</p> 	<p>TA026-16 Landing Gear Assembly</p> 	
<p>TA026-17 F-303 3CH Transmitter</p> 	<p>TA026-18 Main Wing</p> 	<p>TA026-19 Horizontal Vertical Tail Wing</p> 	<p>TA026-20 Hatch</p> 



Add: 301 East Mercury Drive, Suite 8 Champaign, IL 61822
Tel: +1(217)402-2040 **Email:** USA@PlaySTEAM.com
 Manufacture By Hangzhou ZT Model Company Limited.
Address: NO 6 Mingde Rd., Puyan, Binjing, Hangzhou, China.

THE FACTORY HAS PASSED ISO9001: 2015 QUALITY MANAGEMENT SYSTEM CERTIFICATION.

COMPANY WEBSITE: www.playsteam.com