

# VOYAGER 400

2.4GHz RC Sailboat instruction Manual



Age range: 14+

## Product

Length of Ship	400mm
Breadth	100mm
Height	672mm
Battery capacity	150mAh lithium battery
Proportion	1:30

Operating frequency range: 2.405GHZ—2.480GHZ

Ambient temperature for using: -5°C~40°C

Maximum transmit power: 17dBm

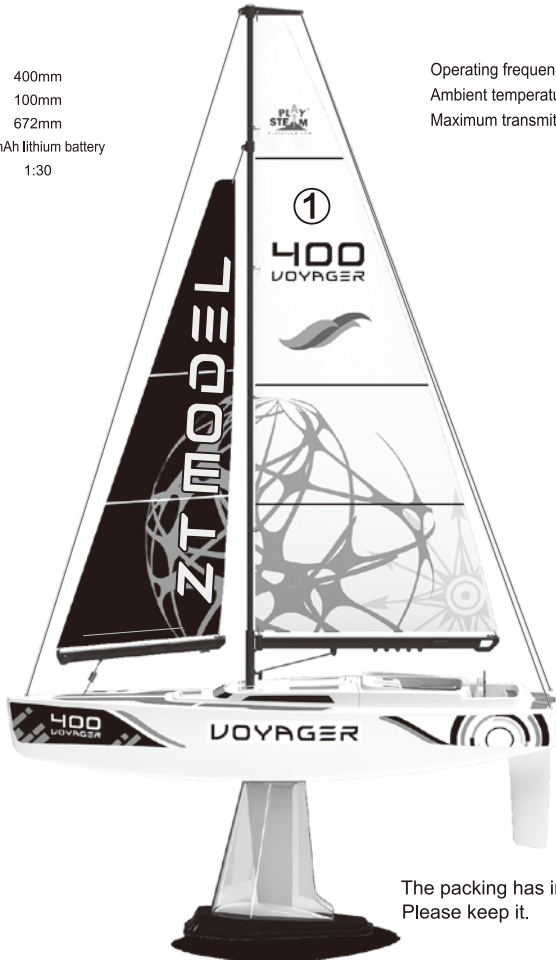

The packing has important information.  
Please keep it.



Add: 301 E Mercury Drive, Suite 8 Champaign, Illinois 61822

Tel: +1(217) 402-2040 Email: USA@PlaySTEM.com

Manufactured By Hangzhou ZT Model Company Limited.

Address: NO 6 Mingde Rd., Puyan, Binjing, Hangzhou, China.

THE FACTORY HAS PASSED ISO9001: 2015 QUALITY MANAGEMENT SYSTEM CERTIFICATION.

COMPANY WEBSITE: [www.playstem.com](http://www.playstem.com)

## ⚠ Announcements

- This model is suitable for people 14 years and up. Younger children should have adult supervision.
- Before sailing, please make sure there is no disturbance in the vicinity before operating.
- It is forbidden to sail on the water where someone is swimming, otherwise you may hurt someone.
- Once the transmitter and receiver are powered on, confirm the two are communicating and the controls are operating appropriately.
- Do not sail where there is debris or people.
- Turn on the remote control before each voyage then turn on the power supply of the receiver.  
Before playing, please turn on the remote control first, and then turn on the power of the receiver.  
When done playing, turn off the receiver power first then the power to the transmitter.
- If there is water in the hull, pour the water out.
- The model receiver has low voltage protection function. If the battery power is insufficient during playing, please replace the battery in time.
- If the boat shows difficulty in turning, charge the battery.
- When the model is damaged to a certain extent and cannot be repaired, do not continue to use it any more.

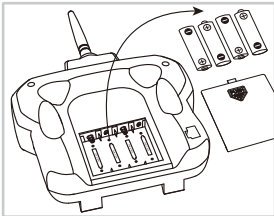

**⚠ Notice** When the controller is not in use, remove the batteries.

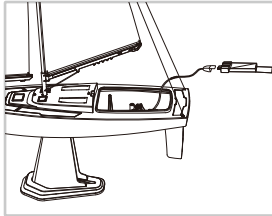





**⚠ Notice** When the model is not in use, the battery should be removed to avoid battery failure.

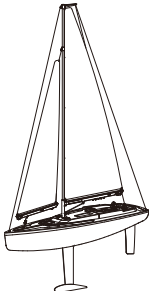
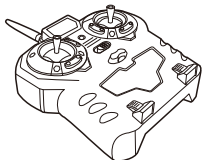

Remove the batteries inside the remote controller and model, and clean them with clean soft rag.

## Assembly parts list

**⚠ Notice** Please check carefully before assembling.

 Sailboat	 Remote control	 Lithium battery	 Number sticker
 Base	 Assembly operation instructions		

**Tools needed** **⚠ Notice** Please be careful when using tools



**Additional and necessary purchase**



Four AA high performance alkaline batteries are required for remote control.

## Install battery

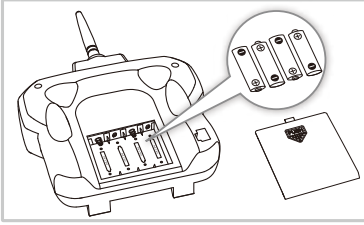

### ■ Installation of remote control battery

Please load 4 AA batteries into the remote controller in the correct positive and negative direction and cover the battery cover.

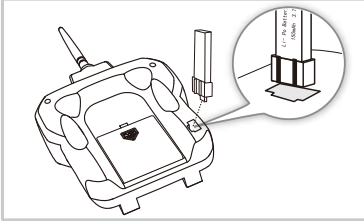

### ■ Lithium Battery Charging

1. Insert randomly matched lithium batteries with spacing ribs face left into the charging hole in the lower right corner of the back of the remote controller.
2. The charging indicator light at the lower part of the front panel of the remote controller is always on, which indicates that it is charging.
3. When the indicator light is out (about 30-minutes), the battery is charged. Disconnect from the controller compartment.

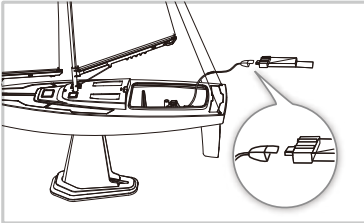

### ■ Installment

1. Open the canopy of the sailboat and insert the charged lithium battery with the protruding side into the plug.
2. Secure the battery with tape in the boat compartment and replace the hatch.

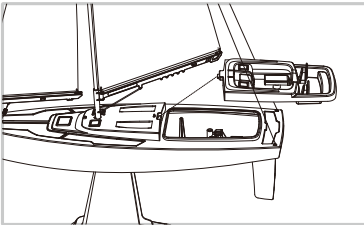

## Points for Attention in Battery Use



### Notice

- Non-rechargeable batteries cannot be recharged.
- Batteries can only be charged under adult supervision
- Batteries should be removed from toys before charging.
- Different types of batteries should not be mixed for using.
- Batteries should be placed at the correct polarity.
- Low batteries should be removed from toy.
- The power supply terminal must not be short-circuited.

## Recognition of Sailing Parts

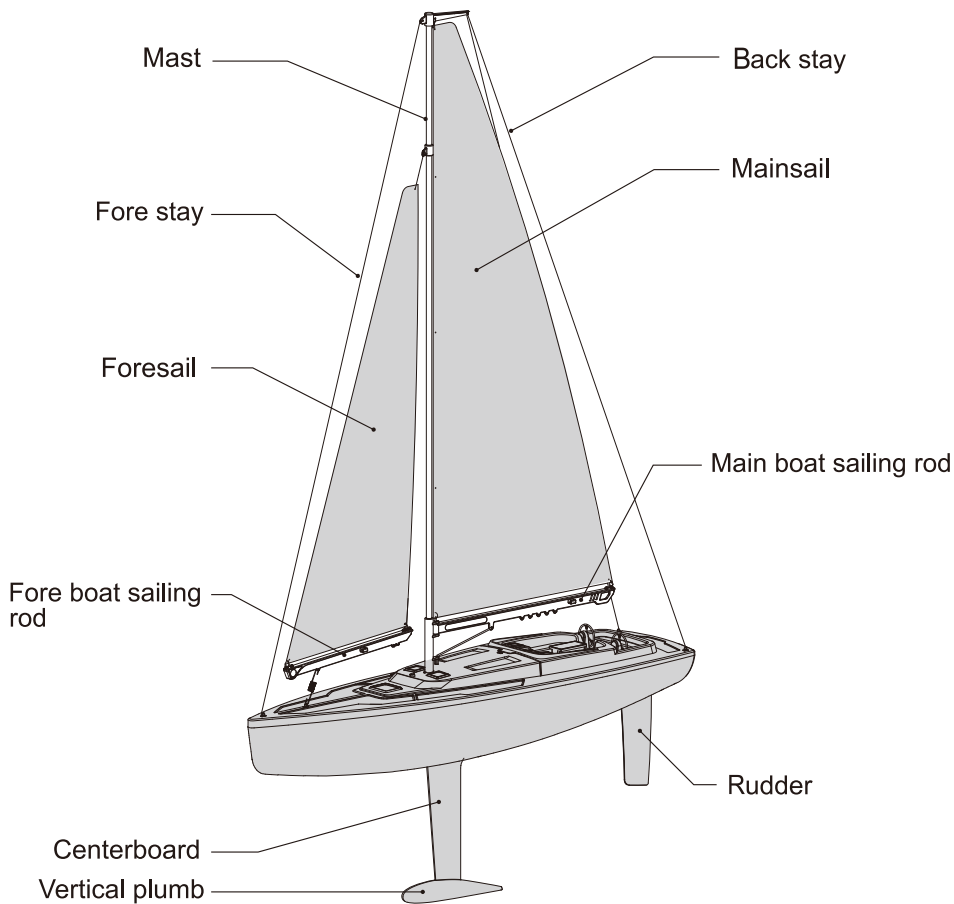

## Attention Before Playing

### ■ Location

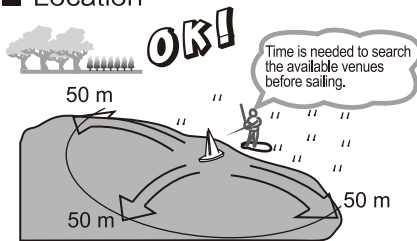

 The most suitable site is an open barrier-free surface with a radius less than 50 m.



Notice

### Announcements

1. To avoid model runaway, do not navigate over flowing water.
2. Don't navigate in lightning, snow or wind.
3. If the model loses power on the surface, please wait patiently and don't try to swim into the water to pick up the boat.

## Remote Controller Component Specification

Serial number	Name	Instruction
01	2.4GHz antenna	
02	Power light	
03	Controller	
04	Right Stick	Control left and right turn
05	Left Stick	Control the Angle Size of Sailing Surface
06	Direction Spinner control	For sharp tuning the direction of steering rudder
07	Angle Spinner control	For sharp tuning the angle of sail surface
08	Power switch	
09	Slings	

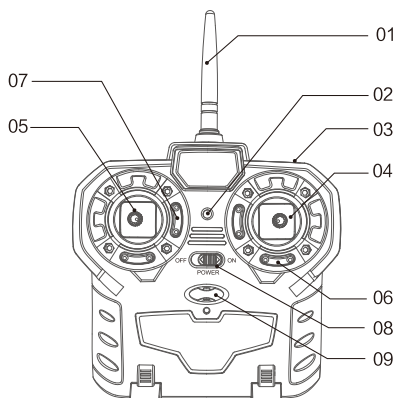

## Safety Protection System

In order to avoid unexpected erroneous operation, this model sets up a security protection system. Before that system is closed, the model will not be able to accept other operation instructions.

- Put the remote control switch ON (the power indicator of the remote controller starts to flicker and you will hear a continuous "beep" sound).
- Push the left handle to the top and then pull it down to the bottom. The sound of the "beep" disappears and the power indicator lights are always on, which means the safety protection system has been closed.

## Method of Signaling Channel connecting

If your transmitter does not seem to be controlling your sailboat, you need to re-link the transmitter and receiver. If your receiver shows a blinking red light, this means it needs to be re-linked to its transmitter.

- Turn the transmitter power switch OFF.
- Plug the battery into the receiver.
- On the **left transmitter stick**, press and hold the **vertical trim control button** (either up or down) while turning the transmitter power switch ON.
- The transmitter will beep 4 times.
- Let go of the **trim control button** and the transmitter will beep 5-8 more times. This is your indication that the linking is in process.
- The LED on the transmitter should blink green. The receiver LED should be solid red.
- Raise and lower the left transmitter stick.
- The transmitter will beep one time. This is your indication that the linking was successful.

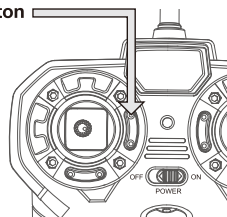

## Remote control operation instructions

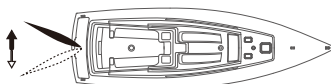
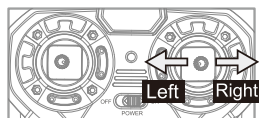

Direction change

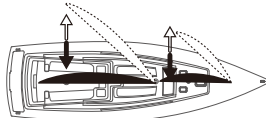
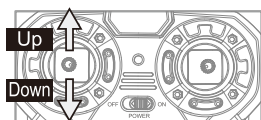

Sail angle change

# Basic knowledge of navigation operation

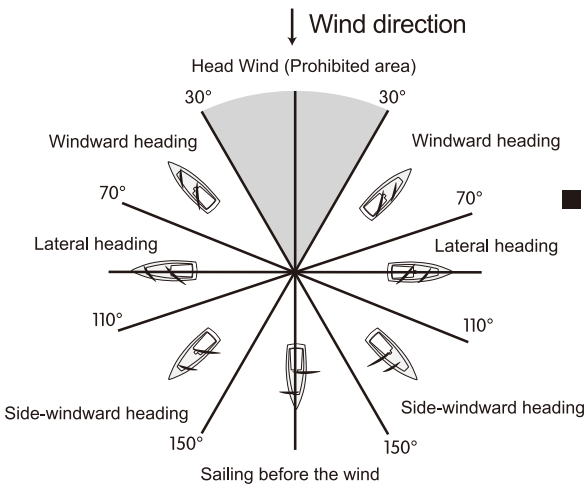
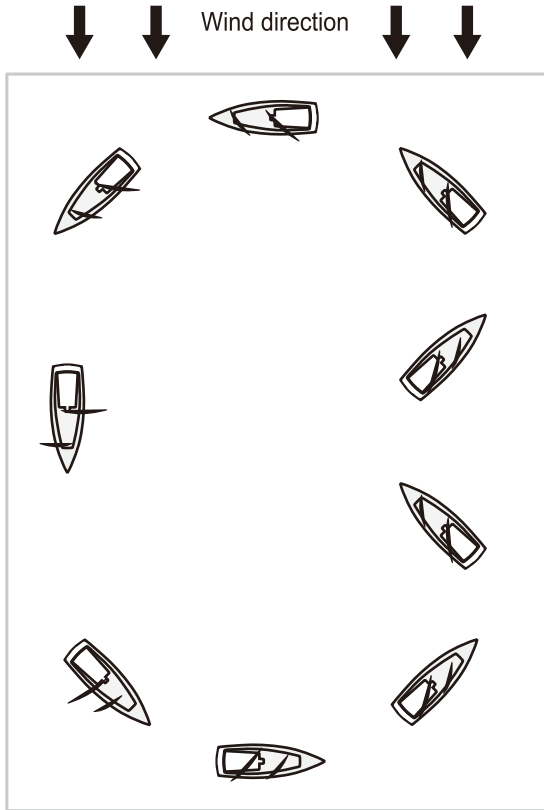

■ Wind Direction Angle: The angle between the wind direction and the bow and stern of a sailing vessel. Wind power is the main driving force for sailing, and wind direction is very important for sailing propulsion. Only by correctly grasping the wind direction angle can we make full use of the wind power.

The degree to which various wind angles are distinguished

## FCC Information

This device complies with Part 15 of the FCC Rules. Operation is subject to the following two conditions: (1) this device may not cause harmful interference, and (2) this device must accept any interference received, including interference that may cause undesired operation.

Warning: Changes or modifications to this unit not expressly approved by the party responsible for compliance could void the user's authority to operate the equipment.

This equipment has been tested and found to comply with the limits for a Class B digital device, pursuant to part 15 of the FCC Rules. These limits are designed to provide reasonable protection against harmful interference in a residential installation.

This equipment generates, uses and can radiate radio frequency energy and, if not installed and used in accordance with the instructions, may cause harmful interference to radio communications. However, there is no guarantee that interference will not occur in a particular installation. If this equipment does cause harmful interference to radio or television reception, which can be determined by turning the equipment off and on, the user is encouraged to try to correct the interference by one or more of the following measures:

- Reorient or relocate the receiving antenna.
- Increase the separation between the equipment and receiver.
- Connect the equipment into an outlet on a circuit different from that to which the receiver is connected.
- Consult the dealer or an experienced radio/ TV technician for help.

Electrical and electronic equipment that are supplied with batteries  
(including internal batteries)  
WEEE Directive & Product Disposal

At the end of its serviceable life, this product should not be treated as household or general waste. It should be handed over to the applicable collection point for the recycling of electrical and electronic equipment, or returned to the supplier for disposal.

Internal / Supplied Batteries.

This symbol on the battery indicates that the battery is to be collected separately.

This battery is designed for separate collection at an appropriate collection point.

